

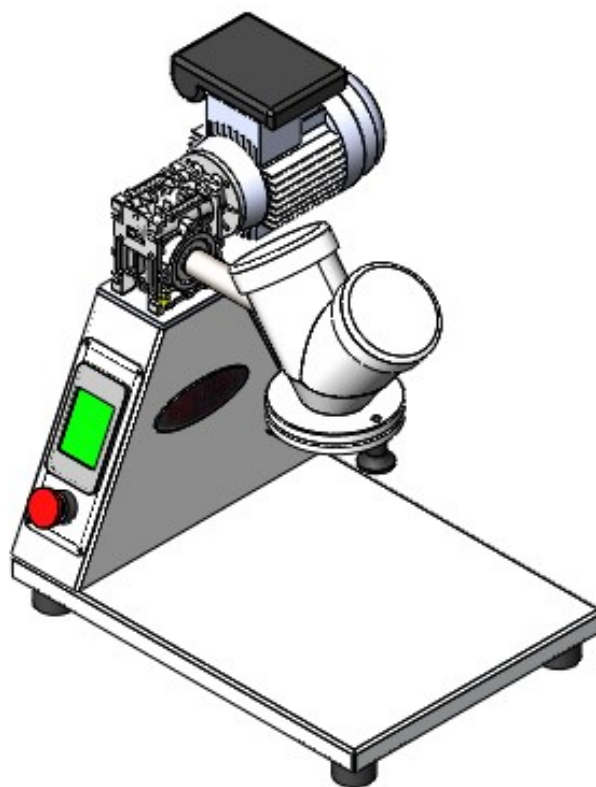

QAQC LAB

www.qclabequipment.com

OPERATING MANUAL



LABORATORY V-MIXER

FTLMV

MANUFACTURER

FILTRA VIBRACIÓN S.L.

TECHNICAL SERVICES

QAQC Lab
589 Rappahannock Drive
White Stone Va 22578

EQUIPMENT

Model:
S/N:
Year of manufacture:



**ELECTRICAL
HAZARD**



**ENTRAPMENT
HAZARD!**

CONTENTS

SECTION 1: DESCRIPTION AND MAIN FEATURES

- 1.1. Introduction
- 1.2. Warranty
- 1.3. Identification
- 1.4. Description of equipment
- 1.5. Applications
- 1.6. Technical Features

SECTION 2: SAFETY PRECAUTIONS

- 2.1. Safety
- 2.2. General safety precautions

SECTION 3: HANDLING AND INSTALLATION

- 3.1. Unpacking
- 3.2. Fitting the mixer
- 3.3. Machine operation

SECTION 4: EQUIPMENT USE

- 4.1. Supply
- 4.2. Unloading

SECTION 5: MAINTENANCE

- 5.1. Periodical inspections
- 5.2. Parts

SECTION 6: SCRAPPING

SECTION 1: DESCRIPTION AND MAIN FEATURES

- 1.1. Introduction**
- 1.2. Warranty**
- 1.3. Identification**
- 1.4. Description of equipment**
- 1.5. Applications**
- 1.6. Technical Features**

1.1. INTRODUCTION

This manual contains all the information considered necessary for the understanding, installation, use and maintenance of this equipment manufactured by FILTRA VIBRACIÓN, S.L.

What is contained within this manual is not a complete description of the various parts, nor a detailed explanation of how they work. However, the user will find in this manual, information which is very useful for the successful installation and safe, correct use and maintenance of the equipment.

The correct operation and useful life of the equipment depends on taking into consideration the contents of this document.

Non-compliance with the recommendations set out in this manual, negligence and/or inappropriate use of this equipment may lead to the warranty being considered void, and any claim of liability for injury or damages being rejected by QAQC LAB

The liability of QAQC Lab, will be limited to the repair or substitution of those products or components which are defective.

On reception of the equipment check that:

- The packaging is not damaged to the point where the equipment itself is damaged.
- The supplied goods correspond to the order specifications.
- There is no damage to the equipment exterior.

In the case of the supplied goods not corresponding to the order or there being damage to the equipment exterior, report the situation immediately, both to the carrier and to QAQC Lab

Keep all packaging until the correct operation of the equipment has been assured. If the equipment has to be returned, then the original packaging is the most adequate.

1.2. WARRANTY

- The warranty period for the equipment is for two years from its dispatch date.
- The warranty includes parts (except consumables) and labour for any repair.
- The repair is free of charge within the FILTRA VIBRACIÓN, S.L. installations (transport costs to and from the installations to be paid by the customer).
- The warranty does not cover damage caused during transport or installation.
- Any repair deriving from inappropriate use of the equipment or overload will not be covered by the warranty.
- Any modification to the equipment unauthorized by the manufacturer, or the use of parts which are not FILTRA originals, will void the warranty.

1.3. IDENTIFICATION

The equipment serial number will be on the equipment in the form of a label or plate which, along with other data, will state:

- Model.
- Serial number.
- Year of manufacture.

This information must always be given when requesting parts for the equipment, or for any other matter relating to it.

1.4. DESCRIPTION OF THE EQUIPMENT

The range of **Venus** laboratory mixers comprises 4 models which go from 0.5 to 8 l total capacity with a useful product capacity of 50%.

This type of mixers allow a smooth mix without deforming the product particles.

The characteristic design of these V-mixers allows a homogeneous mixing, a perfect unloading since it does not have blind angles where the product may be retained and the specific internal polishing allows its perfect unloading, whilst also allowing fast and easy cleaning.

The inspection covers are manufactured in natural silicone, which allows fast and easy loading of the product to mix. This type of silicone does not alter the nature of the product.

The hermetic sealing system respects the environment, and allows simple product evacuation.

1.5. APPLICATIONS

These mixers have multiple applications, ideal for homogeneous mixing with additives and other components.

Used in laboratories of different sectors such as, for example, in flours (wheat, fish...) , ceramic enamels, powdered or granulated plastics, artificial fertilisers, powdered milk, chocolates, pharmaceutical products, etc.

1.6. TECHNICAL SPECIFICATIONS

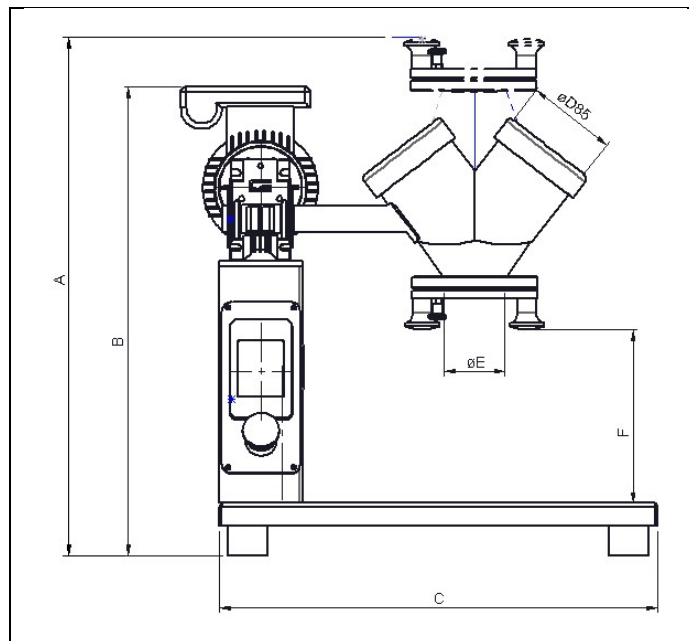

(mm)	1 l.	2 l.	4 l.	8 l.
A	450	500	705	805
B	315	445	605	700
C	415	415	500	600
D	63	104	133	133
E	60	60	60	60
F	128	128	158	200

FTLMV-0.5			0.12 CV	0.5l
FTLMV-01			0.12 CV	1 l
FTLMV-02	220-240 V	50-60 Hz	0.12 CV	2 l
FTLMV-04			0.12 CV	4 l
FTLMV-08			0.25 CV	8 l

SECTION 2: SAFETY PRECAUTIONS

2.1. Safety

2.2. General safety precautions







2.1. SAFETY

It is recommended that this manual, and specifically the safety precautions, is read carefully, paying special attention to those operations which are particularly dangerous.

Filtra Vibración rejects all liability for any non-compliance with the standards covering safety precautions and accident prevention described here. In addition they reject liability for damage caused due to improper use of the equipment or to unauthorized modifications made.

Pay attention to the danger signs which appear in this manual: these precede the indication of a potential danger.

2.2. GENERAL SAFETY PRECAUTIONS

	General danger
	Danger: High-voltage
	Danger: Moving parts
	Obligation: Connect to the earth
	Obligation: Use eye protection
	Obligation: Use insulating gloves

When electrical equipment is used it is necessary to adopt adequate safety precautions in order to reduce the risk of fire, electric shock and injury to personnel.

Before using the equipment read carefully and memorise the following safety precautions. After reading this manual, keep it for future reference.

- Keep the work area clean and tidy. Untidy areas and environments increase the risk of accidents.
- Any type of verification, testing, cleaning, maintenance or change and substitution of parts must be carried out with the equipment turned off and the plug disconnected from the power supply.
- The handling or use of this equipment by children, people without experience, or those in poor health is absolutely prohibited.
- Verify that the power supply installation complies with the regulations for the country in which the equipment is being installed.
- **This equipment must be connected to a 220V power supply which includes an earth connection.**



SECTION 3: HANDLING AND INSTALLATION

3.1. Unpacking and unloading

3.2. Fitting the mixer

3.3. Machine operation

In case of doubt concerning the installation of the sieve shaker, contact the FILTRA VIBRACIÓN, S.L. technical department for advice.

3.1. UNPACKING



Personnel performing the loading, unloading and movement of the equipment must have full knowledge of the lifting equipment to be used.

- The equipment is delivered assembled and with the power cable detachable.
- Check that the equipment has not suffered any knocks or imperfections during transit. It is important to check the requested components and accessories. If there is any difference between the ordered material and that delivered then contact your sales agent without delay.

3.2. FITTING THE MIXER



The correct levelling of the machine will guarantee perfect operation.

- It is necessary for the floor to be as level as possible in the place where the equipment is to be installed.
- The work area for the equipment should be free from obstacles and elements which make working difficult for operators.
- Incorrect observation of the label information may cause damage to the mechanical or electrical components, or both.

3.3. MACHINE OPERATION



- Earthing of the mixer is compulsory.
- Always check that the voltage and frequency of the supply correspond to those indicated on the equipment identification plate before switching on the supply.

- Connect the connection cable to the socket positioned on the rear part of the mixer
- Connect the other end of the connection cable to the grid socket
- Switch on the rear socket to power the front screen.
- Follow the instructions for use of the Filtra Vibración S.L. screen.

SCREEN INSTRUCTIONS FOR USE

- **Boot Screen**



By default this screen appears every time we start the system or every time it restarts due to emergency shutdown, its estimated loading time is 5 seconds.







3.3.1- HOME SCREEN

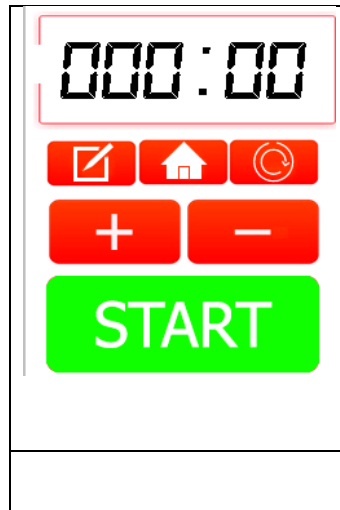

When the boot screen finishes the process it moves to the home screen where we have a button that will redirect us to the following screen.

3.3.2- BASIC CONFIGURATION SCREEN



In this section, we have the basic configuration, i.e. up  and down  stopwatch time, Restart stopwatch . edit time , back to Home screen . Start Program , and finally Information .

3.3.3- WORKING TIME EDITION



On accessing the edit time screen, we have the following interface to change the time we must click on the number of each section.

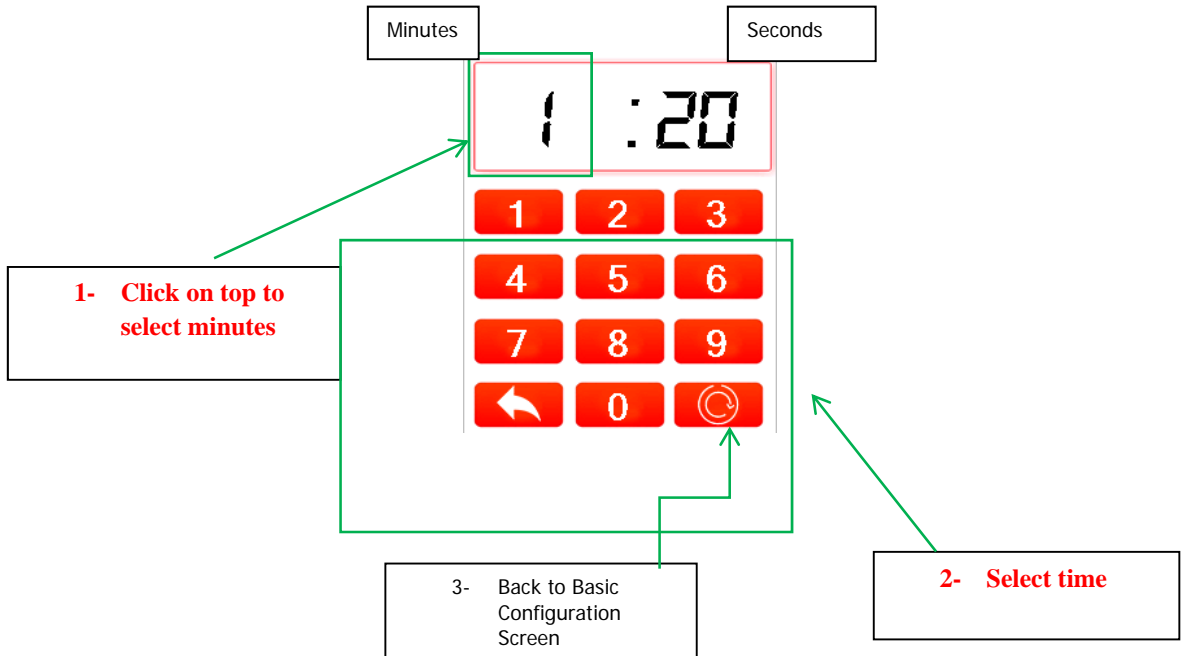

The laboratory mixers have a working time limited to 2 hours continuous maximum use, this time cannot be exceeded.

3.3.4- INFORMATION 



In this section we have information on what each icon is, the sections in green are for next page.

3.3.5- START



When we press the “START” button the countdown we have previously selected will start and the button will change to a RED colour and with the word “STOP”. When we press the “STOP” button the button will change to “START” and the time will stop.

3.3.7- RESET

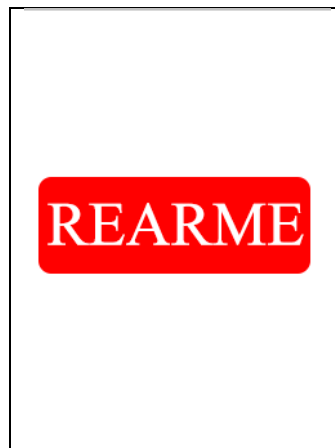

When we press the emergency stop, the machine will automatically stop suddenly and the screen will show the “RESET” message, this is conditional upon the emergency button, ***whilst this activates the emergency stop button we cannot move from this section, therefore, it is not possible to start the machine. Until we undo the emergency button we cannot move to home.***

SECTION 4: EQUIPMENT USE

4.1. Supply

4.2. Unloading

4.1. FEEDING

- Place the mixer so that the loading inlets are in the upper part, remove the silicone covers and introduce the product to mix, that the unloading outlet is totally closed and sealed.
- The amount of product to load must occupy approximately 50% of the total volume of the mixer to achieve an optimum mixing.

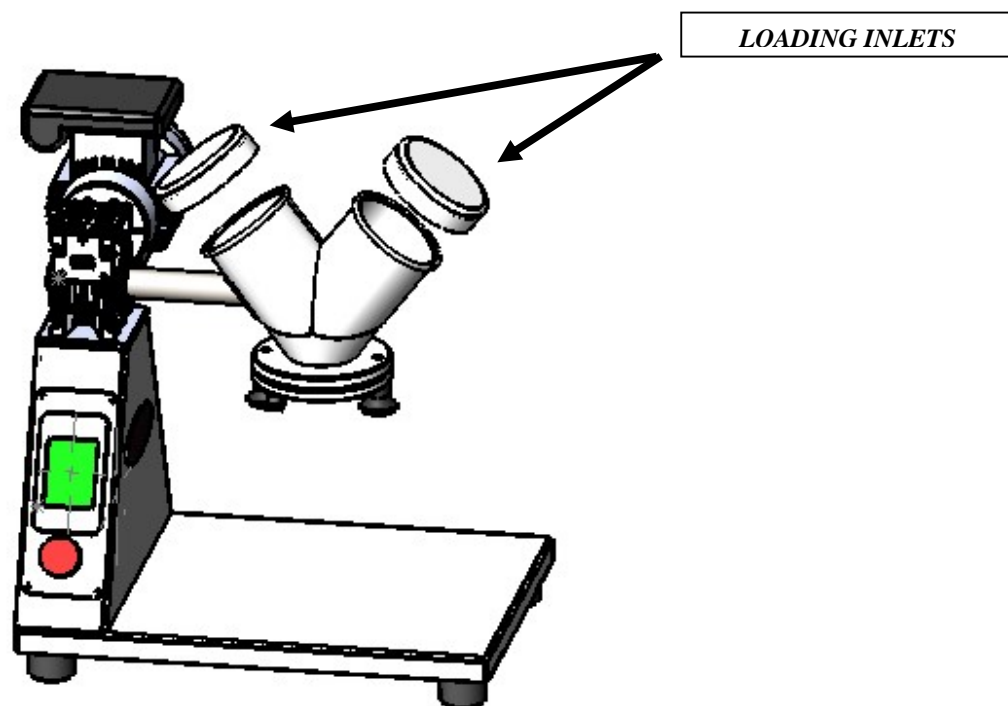

The optimum mixing time is estimated depending on the type of product to mix and according to the desired result.

4.3. UNLOADING

Once disconnected, the apparatus opens the unloading terminal and rotates the lid, opening the mouth and letting the mixed product fall.

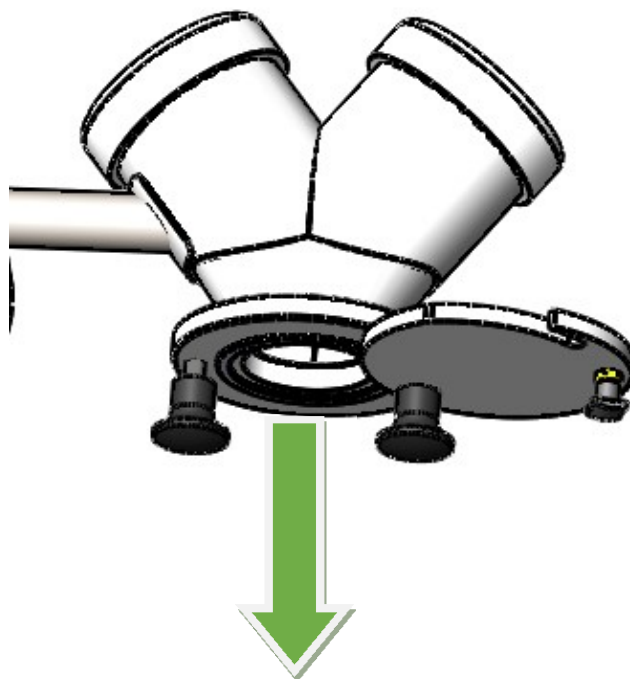

SECTION 5: MAINTENANCE

5.1. Periodical inspections

5.2. Parts

5.1. PERIODICAL INSPECTIONS

Periodical inspections, based on the degree of use and the severity of the application, are the best way to keep the sieve shakers in good condition.

The gear motor is lubricated with special "long-life" greases and no lubrication is necessary. Should lubrication be necessary, use AGIP TELIUM USF320 mineral grease.

Cleaning and product extraction

Clean inside the body with a paintbrush

5.4. PARTS

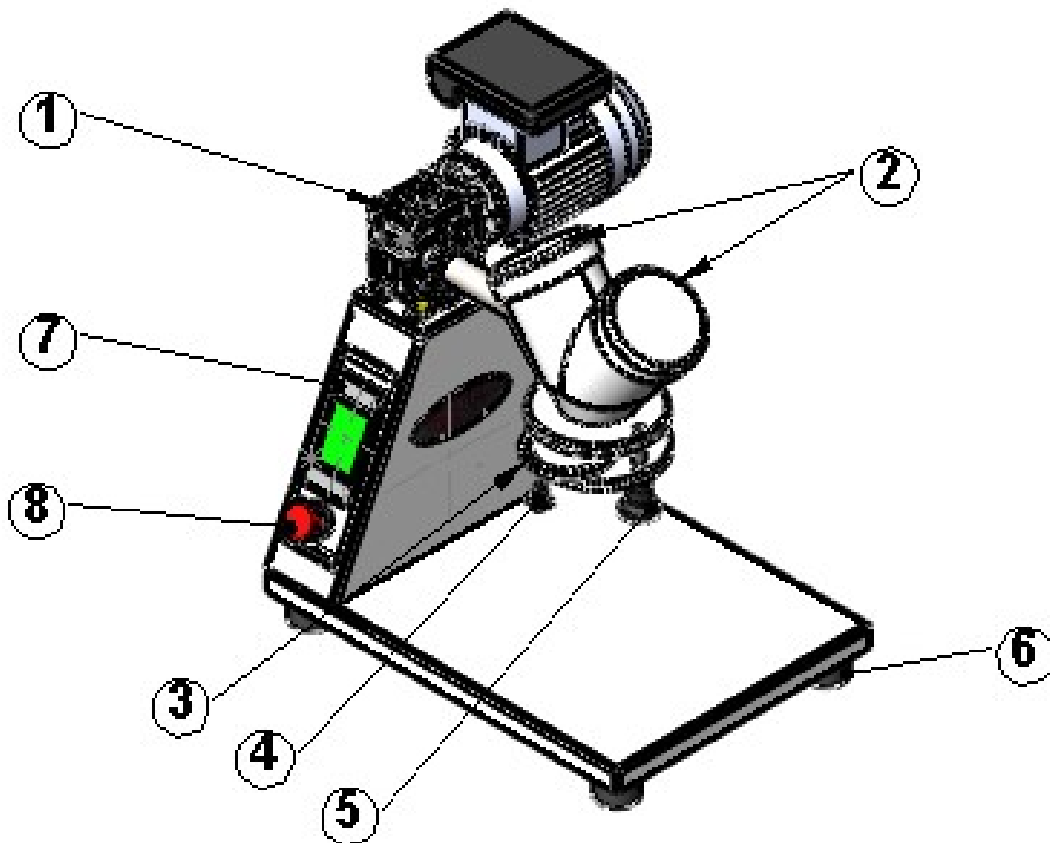

FTLMV-0.5L

POSITION	REFERENCE	DESCRIPTION	QUANTITY x MACHINE
1	619 COM0165	GEAR MOTOR	1
2	619 FTI0005	SILICONE COVER	2
3	619 FTLMV0.5L1106	OUTLET SILICONE SEAL	1
4	619 COM0141	M5 KNOB	1
5	619 COM0173	M8 KNOB	2
6	619 COM0100	SILENBLOCKS (LEGS)	4
7	619 COM0527	TOUCHSCREEN	1
8	619 COM0522	EMERGENCY STOP BUTTON	1

FTLMV-1L

POSITION	REFERENCE	DESCRIPTION	QUANTITY x MACHINE
1	619 COM0165	GEAR MOTOR	1
2	619 FTI0006	SILICONE COVER	2
3	619 FTLMV12L1106	OUTLET SILICONE SEAL	1
4	619 COM0141	M5 KNOB	1
5	619 COM0173	M8 KNOB	2
6	619 COM0100	SILENBLOCKS (LEGS)	4
7	619 COM0527	TOUCHSCREEN	1
8	619 COM0522	EMERGENCY STOP BUTTON	1

FTLMV-2L

POSITION	REFERENCE	DESCRIPTION	QUANTITY x MACHINE
1	619 COM-0165	GEAR MOTOR	1
2	619 FTI0004	SILICONE COVER	2
3	619 FTLMV12L1106	OUTLET SILICONE SEAL	1
4	619 COM0141	M5 KNOB	1
5	619 COM0173	M8 KNOB	2
6	619 COM0100	SILENBLOCKS (LEGS)	4
7	619 COM0527	TOUCHSCREEN	1
8	619 COM0522	EMERGENCY STOP BUTTON	1

FTLMV-4L

POSITION	REFERENCE	DESCRIPTION	QUANTITY x MACHINE
1	619 COM0174	GEAR MOTOR	1
2	619 FTI0001	SILICONE COVER	2
3	619 FTLMV48L1106	OUTLET SILICONE SEAL	1
4	619 COM0141	M5 KNOB	1
5	619 COM0173	M8 KNOB	2
6	619 COM0100	SILENBLOCKS (LEGS)	4
7	619 COM0527	TOUCHSCREEN	1
8	619 COM0522	EMERGENCY STOP BUTTON	1

FTLMV-8L

POSITION	REFERENCE	DESCRIPTION	QUANTITY x MACHINE
1	619 COM0138	GEAR MOTOR	1
2	619 FTI0001	SILICONE COVER	2
3	619 FTLMV48L1106	OUTLET SILICONE SEAL	1
4	619 COM0141	M5 KNOB	1
5	619 COM0173	M8 KNOB	2
6	619 COM0100	SILENBLOCKS (LEGS)	4
7	619 COM0527	TOUCHSCREEN	1
8	619 COM0522	EMERGENCY STOP BUTTON	1

SECTION 6: SCRAPPING

6.1. Instructions for scrapping

6.1. INSTRUCTIONS FOR SCRAPPING

The "separate collection" symbol which appears on the equipment, and this instruction manual, indicate that the waste must be collected separately.



Separate collection

Thus, the user will have to deliver (or have delivered) the waste to selective waste collection centres set up by local authorities, or to the vendor, in the event that a new piece of equivalent equipment is being purchased.

Selective waste collection and the following procedures for treatment, recovery and elimination favour the production of equipment using recycled material, and limit the negative effects that inadequate management of the waste could cause to the environment and to health.

The incorrect elimination of the product by the user may lead to the application of the administrative sanctions applicable under current law.