

Product Specification

Specification Number

675 A9265

Revision

01

Part No. 675 A9265

Description Toggle Drum 5L

Materials of Construction:

- Body: 316 stainless steel
- Lid: 316 stainless steel
- Toggles: 304 stainless steel
- Handles: 304 stainless steel
- Gasket: Silicone (FDA 177.2600 and USP Class VI compliant)

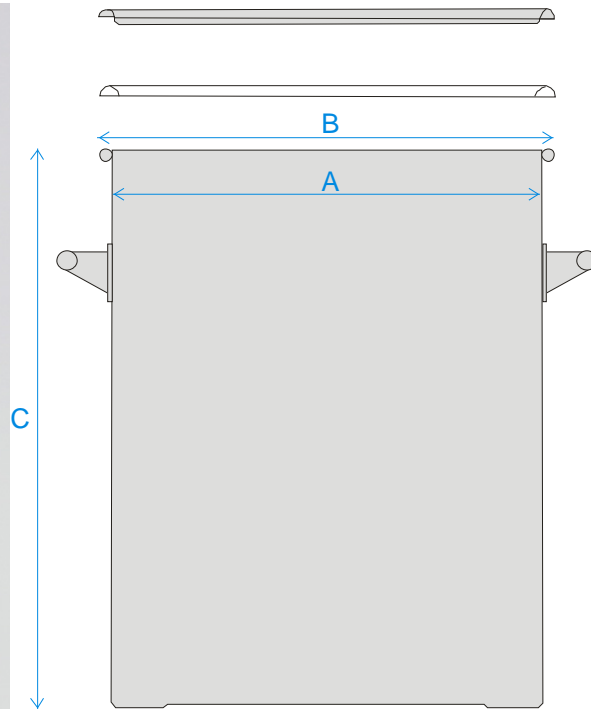

Nominal Volume: 5 Litres

Brimful Volume: 6 Litres

Method of Construction: Welds ground and polished

Surface Finish: Better than 0.5 microns Ra

Dimensions
 A = 196 mm
 B = 216 mm
 C = 200 mm

Graduation Marks: None

Handles: 2 side handles welded onto patch plates

Number of Toggles: 4

Weight: 2.7 Kg (body + gasket + lid)